

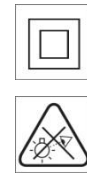

0881

URBAN LIGHTING

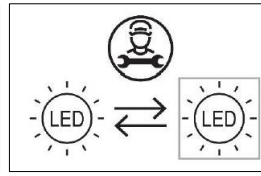
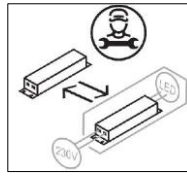

WARNING

ANY MODIFICATION TO THIS FITTING IS FORBIDDEN WITHOUT PRIOR AUTHORIZATION

Our policy is the constant improvement of the product. We reserve the right to modify the characteristics of the equipment without prior notice. Please refer to the website www.arcluce.it for this and other technical documents continually updated.

All information is presented in good faith. no responsibility may be imputed to us for errors, omissions or incorrect interpretations.

The photographs and drawings are within the limits of the quality of the printed reproduction, not binding and indicative only.



Directive 2002/96/CE (Waste Electrical and Electronic Equipment - WEEE). The crossed out wheeled bin label that this product should not be disposed how the normal household waste stream, but with a separate collection; this in order to prevent potential negative consequences for the environment and the human health. For more details on available collection facilities please contact your local government office or the dealer where you purchased this product.

The safety and the proper functioning of the fitting is guaranteed only respecting the electrical Standards and this mounting instructions; therefore it's necessary to keep them.

Installation should be carried out by a suitable qualified person. Always refer to electrical data on the fixture label.

The light source contained in this luminaire shall only be replaced by the manufacturer or his service agent or a similar qualified person. Only use original ARCLUCE spare parts.



Turn off power before maintenance (1).

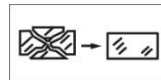

Replace any cracked shield (2)



Risk group 1 (IEC/TR62778). Do not stare at operating LED (3)

SPECIFICATIONS

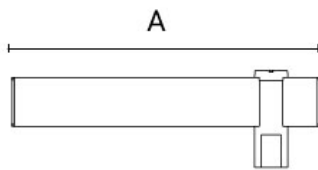

SINGLE

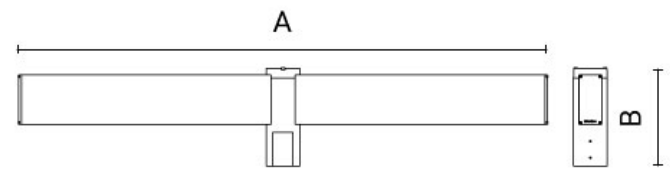
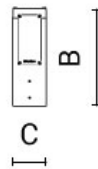

DOUBLE

MECHANICAL		MECHANICAL	
Dimensions:	A: 950 mm B: 296 mm C: 102 mm	Dimensions:	A: 1600 mm B: 296 mm C: 102 mm
Tenon:	OD: Ø 60mm H: 100mm	Tenon:	OD: Ø 60mm H: 100mm
Weight:	7.3 Kg	Weight:	12,2 Kg
Rated Ta:	-20°C ÷ +25°C	Rated Ta:	-20°C ÷ +25°C
Wind exposure:	0.15 m ²	Wind exposure:	0.25 m ²
ELECTRICAL		ELECTRICAL	
Wiring:	ON/OFF, DALI	Wiring:	ON/OFF, DALI
Input:	220-240V 50/60Hz	Input:	220-240V 50/60Hz

INSTALLATION

1. Wire plug according to diagram.
2. Connect plug with socket and slip fixture on tenon.
3. Slide fixture on tenon and tighten grubs.

1



Turn off power (1).



If the external flexible cable or cord of this luminaire is damaged, it shall be exclusively replaced by the manufacturer or his service agent or a similar qualified person in order to avoid a hazard (2).



Where the luminaire is not provided with the installation Coupler but with tails, it shall be connected to the supply by an installation coupler STUCCHI type 3701/2 (for the CEI version) or TECHNO TH387 (for the DALI version) or other that it has at least the same equivalent technical characteristics or better and it is certified with its EN/IEC Product Standard (3).

ON/OFF

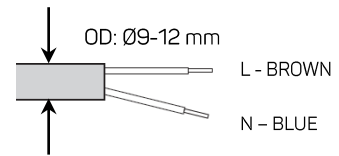
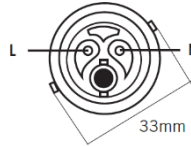

DALI

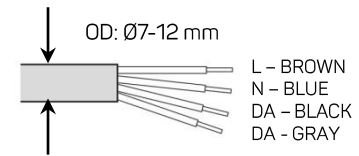
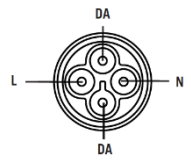

Between DALI control lines and Mains there is a BASIC insulation (4).

2

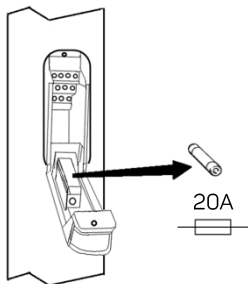

Protect fixtures using poles with 20A fuse (1).

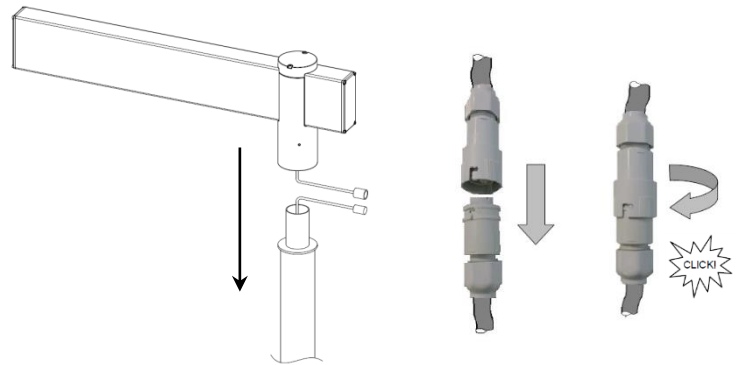
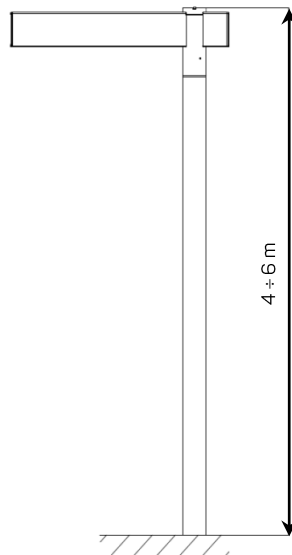

Connect plug to socket and secure with lock ring (2).



The cable connection must have an IP rating at least equal or higher than the fixture itself (3).



Do not pinch the cable (4).



Lock uniformly the fastening screws to obtain a correct alignment (6 Nm) (5).





For applications with $T_a > 25^\circ\text{C}$ do respect the following time schedule (6).

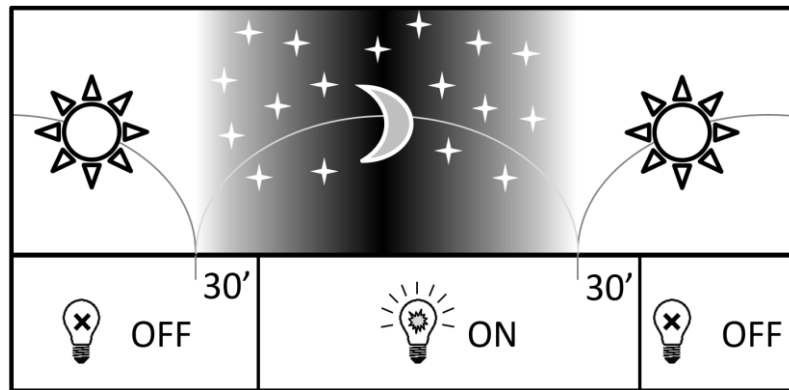

AVERTISSEMENTS

TOUTE MODIFICATION DE CET APPAREIL, SANS AUTORISATION, EST INTERDITE

Notre politique est l'amélioration constante du produit. Nous nous réservons le droit de modifier les caractéristiques de l'équipement sans préavis. Veuillez-vous référer au site web www.arcluce.it pour cela et d'autres documents techniques continuellement mis à jour. Toutes les informations sont présentées de bonne foi, aucune responsabilité ne peut nous être imputée pour des erreurs, des omissions ou des interprétations incorrectes. Les photographies et les dessins sont dans les limites de la qualité de la reproduction imprimée, ils ne sont pas contraignants et à titre indicatif seulement.

Directive 2002/96/CE (Déchets d'Équipements Électriques et Électroniques - DEEE). L'étiquette de la poubelle à roulettes barrée indique que ce produit ne doit pas être éliminé comme les déchets urbains mais par une collecte séparée; ceci afin d'éviter des conséquences négatives potentielles sur l'environnement et la santé humaine. Pour plus de détails sur les installations de collecte disponibles, veuillez contacter votre administration locale ou le revendeur auprès duquel ce produit a été acheté.

La sécurité et le bon fonctionnement du luminaire sont garantis uniquement en respectant les normes électriques et les présentes instructions de montage; donc il est nécessaire de les garder. L'installation doit être effectuée par une personne qualifiée appropriée. Toujours se référer aux données électriques sur l'étiquette du luminaire la source lumineuse contenue dans ce luminaire ne doit être remplacée que par le fabricant, son agent de service ou une personne qualifiée similaire. N'utilisez que des pièces de rechange ARCLUCE.

(1) Avant toute intervention sur l'appareil éteindre l'alimentation. (2) Remplacer tout écran de protection fissuré. (3) Groupe à risque 1 (IEC/TR62778). Ne regardez pas directement les DELs en fonction.

INSTALLATION:

1. Câbler la fiche conformément au schéma.
2. Connecter la fiche à la prise
3. Faire glisser le luminaire sur le tenon et serrez les vis sans tête.

IMAGES:

(1.1) Éteindre l'alimentation. (1.2) Si le câble flexible externe ou le câble de ce luminaire sont endommagés, il doit être remplacé exclusivement par le fabricant, son agent de service ou une personne qualifiée similaire, afin d'éviter tout risque. (1.3) Si l'appareil n'est pas fourni avec le coupleur d'installation, il doit être connecté à l'alimentation avec un connecteur TECHNO TH387 ou un autre connecteur ayant les mêmes caractéristiques techniques ou des meilleures caractéristiques techniques et certifié selon les standards EN / IEC. (1.4) Entre les lignes de commande DALI et l'alimentation primaire est présente une isolation BASIQUE. (2.1) Protégez les appareils en utilisant des mats avec fusibles de 20A. (2.2) Connecter la fiche à la prise et fixez-la avec la bague de blocage. (2.3) La connexion du câble doit avoir un indice IP au moins égal ou supérieur à celui de l'appareil lui-même. (2.4) Ne pincez pas et n'endommagez pas le câble. (2.5) Serrer les vis uniformément pour obtenir un alignement correct (6 Nm). (2.6) Pour les applications avec $T_a > 25^\circ\text{C}$, respectez les plages horaires suivantes.

AVVERTENZE

SONO VIETATE MODIFICHE ALL'APPARECCHIO SENZA AUTORIZZAZIONE

Perseguiamo una politica di costante miglioramento del prodotto. Ci riserviamo il diritto di modificare le caratteristiche dell'apparecchiatura senza preavviso. Si prega di fare riferimento al sito www.arcluce.it per questo e altri documenti tecnici che vengono continuamente aggiornati. Tutte le informazioni sono presentate in buona fede. Nessuna responsabilità ci può essere attribuita per errori, omissioni o interpretazioni errate. Le fotografie e i disegni sono nei limiti della qualità della riproduzione stampata, non sono vincolanti e solo per informazione.

Direttiva 2002/96/CE (Rifiuti di Apparecchiature Elettriche ed Elettroniche - RAEE). Il pittogramma del bidone con ruote barrato indica che questo prodotto non deve essere smaltito come normale rifiuto urbano ma attraverso raccolta separata; questo per evitare potenziali conseguenze negative per l'ambiente e la salute umana. Per i dettagli sulle strutture di raccolta disponibili, contattare l'ufficio governativo locale o il rivenditore presso il quale è stato acquistato il prodotto.

La sicurezza e il corretto funzionamento dell'apparecchio sono garantiti solo rispettando le normative elettriche e queste istruzioni pertanto è necessario conservarle.

L'installazione deve essere eseguita da personale qualificato fare sempre riferimento ai dati elettrici presenti sull'etichetta dell'apparecchio. La sorgente luminosa contenuta in questo apparecchio deve essere sostituita solo dal costruttore o dal suo servizio di assistenza o da personale altrettanto qualificato. Utilizzare solamente pezzi di ricambio originali ARCLUCE.

(1) Prima di qualsiasi intervento sul dispositivo, spegnere l'alimentazione. (2) Sostituire gli schermi di protezione danneggiati. (3) Gruppo di rischio 1 (IEC/TR62778). Non osservare direttamente i LED in funzione.

INSTALLAZIONE

1. Collegare la spina seguendo lo schema.
2. Collegare la spina con la presa.
3. Far scorrere l'apparecchio sulla riduzione e serrare i grani.

IMMAGINI

(1.1) Spegner l'alimentazione. (1.2) Se il cavo flessibile esterno o il cavo di questo apparecchio è danneggiato, deve essere sostituito esclusivamente dal produttore o dal suo agente di assistenza o da una persona ugualmente qualificata per evitare rischi. (1.3) Se l'apparecchio non è fornito con l'accoppiatore di installazione deve essere collegato all'alimentazione con un connettore TECHNO TH387 o un altro connettore che abbia le stesse caratteristiche tecniche o caratteristiche tecniche migliori, e sia certificato EN/IEC Product Standard. (1.4) Tra le linee di controllo DALI e la rete elettrica principale è presente un isolamento fondamentale. (2.1) Proteggere gli apparecchi utilizzando pali con fusibili da 20A. (2.2) Collegare la spina alla presa e fissarla con l'anello di bloccaggio. (2.3) La connessione del cavo deve avere un grado IP almeno uguale o superiore a quello dell'apparecchio stesso. (2.4) Non schiacciare o danneggiare il cavo. (2.5) Serrare uniformemente le viti di fissaggio per ottenere un allineamento corretto (6 Nm). (2.6) Per applicazioni con $T_a > 25^\circ\text{C}$ rispettare le seguenti fasce orarie d'accensione.